

# PowerLift Corner Standing Desk PLCSD



## Key Features



- Lifts up to 450 Lbs.
- Raises up to 45.5"
- Motorized Lift
- Push Button Adjustment
- Programmable Control Switch with 4 Customizable Height Presets
- 3 USB & 2 power outlets for devices
- High-Pressure WilsonArt Laminate
- Scratch/Dirt Resistant Powder Coat
- Recycled Steel
- Premium T-Molding
- Patent Pending

## Available configurations

**Frame Colors**

-  Black
-  White

**Surface Colors**

-  Black
-  White
-  Maple

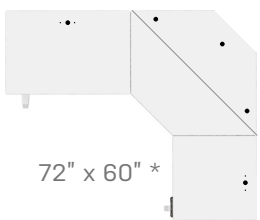
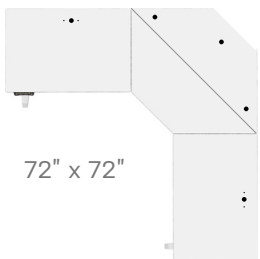
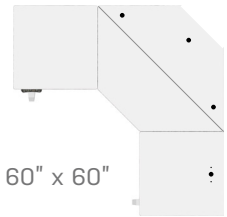

\* the bottom two are NOT interchangeable

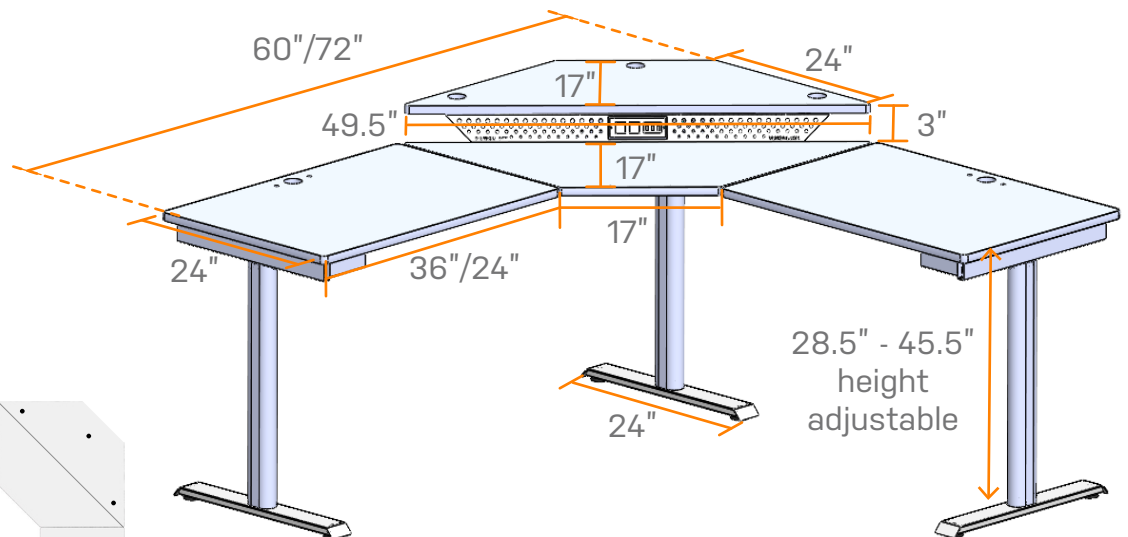

(800) 465-1660  
www.versadesk.com

14108 Towne Ave.  
Los Angeles, CA 90061

